



Mathematics

National 5 Practice Paper E

Paper 1

Duration - 1 hour

Total marks - 40

- You may NOT use a calculator
- Attempt all the questions.
- Use **blue** or **black** ink.
- Full credit will only be given to solutions which contain appropriate working.
- State the units for your answer where appropriate.

FORMULAE LIST

The roots of are $ax^2 + bx + c = 0$ $x = \frac{-b \pm \sqrt{b^2 - 4ac}}{2a}$

Sine rule: $\frac{a}{\sin A} = \frac{b}{\sin B} = \frac{c}{\sin C}$

Cosine rule: $a^2 = b^2 + c^2 - 2bc \cos A$ or $\cos A = \frac{b^2 + c^2 - a^2}{2bc}$

Area of a triangle: $A = \frac{1}{2}ab \sin C$

Volume of a Sphere: $V = \frac{4}{3}\pi r^3$

Volume of a cone: $V = \frac{1}{3}\pi r^2 h$

Volume of a pyramid: $V = \frac{1}{3}Ah$

Standard deviation: $s = \sqrt{\frac{\sum(x-\bar{x})^2}{n-1}} = \sqrt{\frac{\sum x^2 - (\sum x)^2/n}{n-1}}$, where n is the sample size.

1. Evaluate

$$2\frac{1}{3} + \frac{5}{6} \text{ of } 1\frac{2}{5}$$

3

2. Multiply out the brackets and collect like terms.

$$(4x + 2)(x - 5) + 3x$$

3

3. In an experiment involving two variables, the following values for x and y were recorded.

x	1	2	3	4
y	4	2	0	-2

The results were plotted and a straight line was drawn through the points.

Find the gradient of the line and write down its equation.

3

4. Solve the equation

$$\frac{2}{x} + 9 = 16$$

3

5. Given $2x^2 - 2x - 1 = 0$, show that

$$x = \frac{1 \pm \sqrt{3}}{2}$$

4

6. The diagram below shows part of the graph of $y = 36 - (x - 2)^2$.

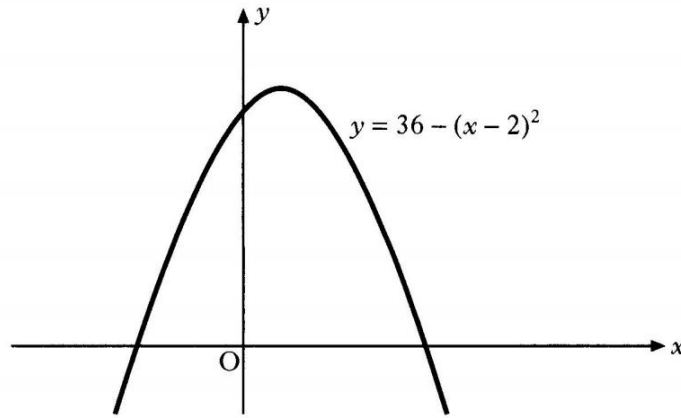

- (a) State the coordinates of the maximum turning point. 2
- (b) State the equation of the axis of symmetry. 1

The line $y = 20$ is drawn.

It cuts the graph of $y = 36 - (x - 2)^2$ at R and S as shown below.

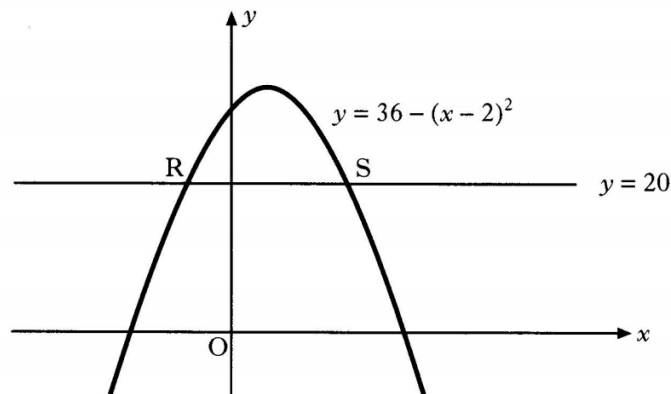

- (c) S is the point (6, 20). Find the coordinates of R. 2

7. A badge is made from a circle of radius 5 centimetres.
Segments are taken off the top and bottom of the circle as shown.
The straight edges are parallel.

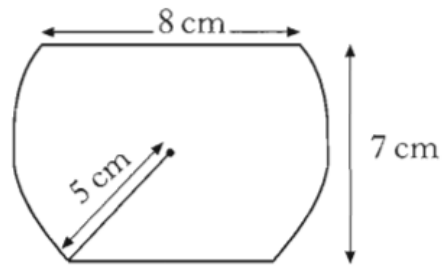

The badge measures 7 centimetres from the top to the bottom.
The top is 8 centimetres wide.

Calculate the width of the base.

5

8. Sketch the graph of $y = \sin 2x^\circ$, $0 \leq x \leq 360$.

3

9. $f(x) = 4\sqrt{x} + \sqrt{2}$

(a) Find the value of $f(72)$ as a surd in its simplest form.

3

(b) Find the value of t , given that $f(t) = 3\sqrt{2}$.

3

10. The height of a triangle is $(2x - 5)$ centimetres and the base is $2x$ centimetres.

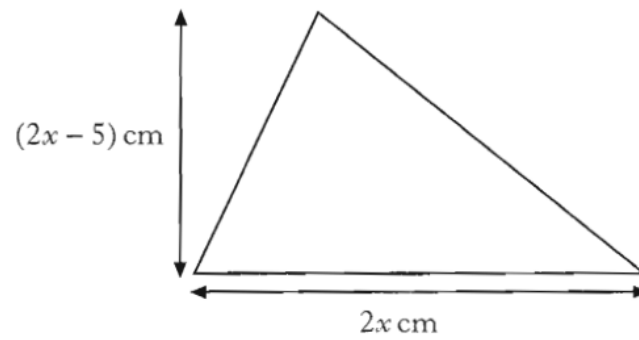

The area of the triangle is 7 square centimetres.

Calculate the value of x .

5

[End of question paper]



Mathematics

National 5 Practice Paper E

Paper 2

Duration - 1 hour and 30 minutes

Total marks - 50

- You may use a calculator
- Attempt all the questions.
- Use **blue** or **black** ink.
- Full credit will only be given to solutions which contain appropriate working.
- State the units for your answer where appropriate.

FORMULAE LIST

The roots of are $ax^2 + bx + c = 0$ $x = \frac{-b \pm \sqrt{b^2 - 4ac}}{2a}$

Sine rule: $\frac{a}{\sin A} = \frac{b}{\sin B} = \frac{c}{\sin C}$

Cosine rule: $a^2 = b^2 + c^2 - 2bc \cos A$ or $\cos A = \frac{b^2 + c^2 - a^2}{2bc}$

Area of a triangle: $A = \frac{1}{2}ab \sin C$

Volume of a Sphere: $V = \frac{4}{3}\pi r^3$

Volume of a cone: $V = \frac{1}{3}\pi r^2 h$

Volume of a pyramid: $V = \frac{1}{3}Ah$

Standard deviation: $s = \sqrt{\frac{\sum(x-\bar{x})^2}{n-1}} = \sqrt{\frac{\sum x^2 - (\sum x)^2/n}{n-1}}$, where n is the sample size.

1. $E = mc^2.$

Find the value of E when $m = 3.6 \times 10^{-2}$ and $c = 3 \times 10^8$.
Give your answer in scientific notation.

3

2.

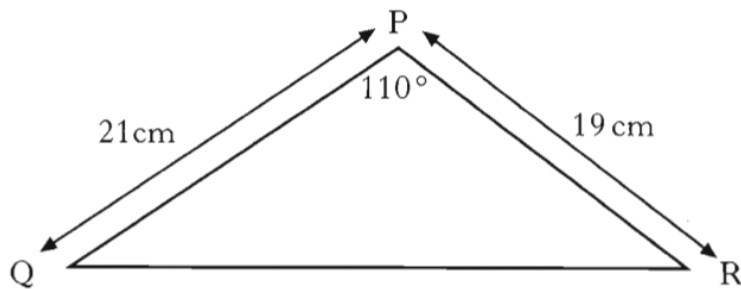

Calculate the area of triangle PQR.

4

3. In the evening, the temperature in a greenhouse drops by 10.4% per hour.
At 8 p.m. the temperature was 28° Celsius.

Find the temperature at 11 p.m.

3

4. Relative to coordinate axes, the point A has coordinates (2, 4, 6).

(a) Find the coordinates of C and D.

(b) Write down the coordinates of B.

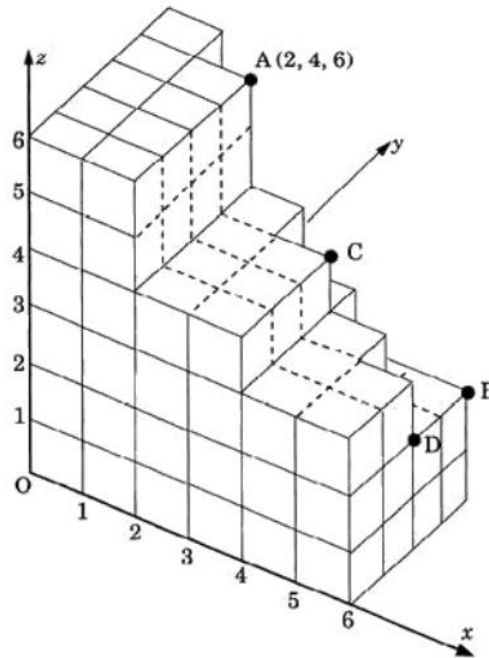

2

1

5. Shampoo is available in travel size and salon size bottles.

The bottles are mathematically similar.



The travel size contains 200 millilitres and is 12 centimetres in height.

The salon size contains 1600 millilitres.

Calculate the height of the salon size bottle.

3

6. A jeweller uses two different arrangements of bead and pearls.

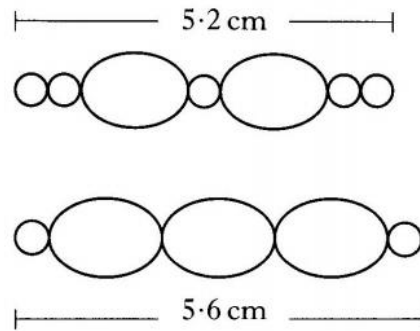

The first arrangement consists of 2 beads and 5 pearls and has an overall length of 5.2 centimetres.

The second arrangement consists of 3 beads and 2 pearls and has an overall length of 5.6 centimetres.

Find the length of **one** bead and the length of **one** pearl.

6

7. A pharmaceutical company makes vitamin pills in the shape of spheres of radius 0.5 centimetres.

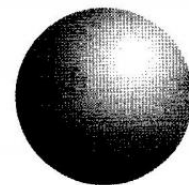

- (a) Calculate the volume of one pill.
Give your answer to **3 significant figures**.

3

The company decides to change the shape of each pill to a cylinder.

The new pill has the same volume as the original and its diameter is 1.4 centimetres.

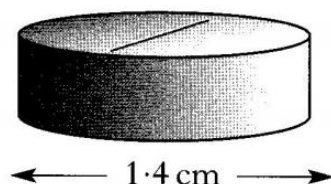

- (b) Calculate the height of the new pill.

3

8. David walks on a bearing of 050° from hostel A to viewpoint V, 5 kilometres away. Hostel B is due east of hostel A. Susie walks on a bearing of 294° from hostel B to the same viewpoint.

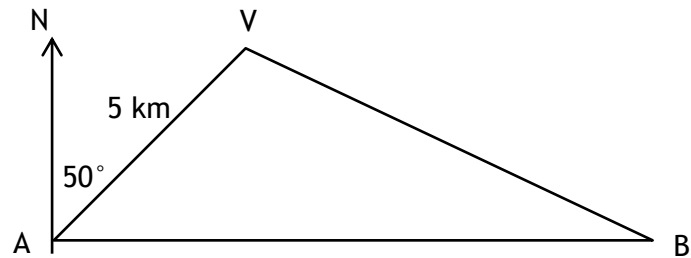

Calculate the length of AB, the distance between the two hostels.

5

9. The chain of a demolition ball is 12.5 metres long. When vertical, the end of the chain is 1.5 metres from the ground.

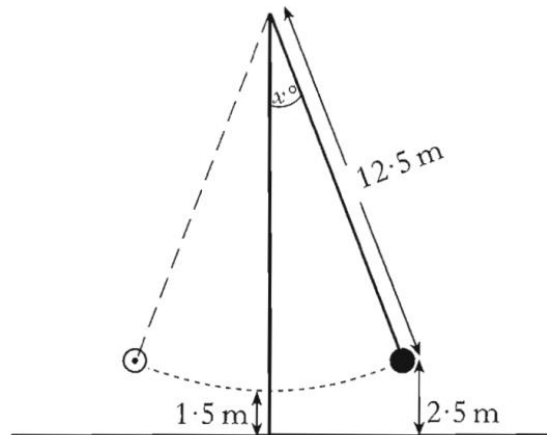

It swings to a maximum height of 2.5 metres above the ground on both sides.

- (a) At this maximum height, show that the angle x° , which the chain makes with the vertical, is approximately 23° .
- (b) Calculate the maximum length of the arc through which the end of the chain swings. Give your answer to 3 significant figures.

4

4

10. Find the range of values of k such that the equation $kx^2 - 4x + 2 = 0$, $k \neq 0$, has real roots.

4

11. (a) Solve algebraically the equation

$$\sqrt{3} \sin x^\circ - 1 = 0 \quad 0 \leq x < 360.$$

3

- (b) Simplify

$$\tan x^\circ \cos x^\circ.$$

2

[End of question paper]