



Mathematics

National 5 Practice Paper B

Paper 1

Duration - 1 hour

Total marks - 40

- You may NOT use a calculator
- Attempt all the questions.
- Use **blue** or **black** ink.
- Full credit will only be given to solutions which contain appropriate working.
- State the units for your answer where appropriate.

FORMULAE LIST

The roots of are $ax^2 + bx + c = 0$ $x = \frac{-b \pm \sqrt{b^2 - 4ac}}{2a}$

Sine rule: $\frac{a}{\sin A} = \frac{b}{\sin B} = \frac{c}{\sin C}$

Cosine rule: $a^2 = b^2 + c^2 - 2bc \cos A$ or $\cos A = \frac{b^2 + c^2 - a^2}{2bc}$

Area of a triangle: $A = \frac{1}{2}ab \sin C$

Volume of a Sphere: $V = \frac{4}{3}\pi r^3$

Volume of a cone: $V = \frac{1}{3}\pi r^2 h$

Volume of a pyramid: $V = \frac{1}{3}Ah$

Standard deviation: $s = \sqrt{\frac{\sum(x-\bar{x})^2}{n-1}} = \sqrt{\frac{\sum x^2 - (\sum x)^2/n}{n-1}}$, where n is the sample size.

1. Evaluate

$$7.18 - 2.1 \times 3.$$

2

2. Evaluate

$$1\frac{1}{8} \div \frac{3}{4}$$

2

3. Solve the inequality $5 - x > 2(x + 1)$

3

4. Given that $f(x) = x^2 + 5x$, evaluate $f(-3)$.

2

5. Vector \mathbf{u} has components $\begin{pmatrix} 3 \\ -2 \\ -1 \end{pmatrix}$ and vector \mathbf{v} has components $\begin{pmatrix} 2 \\ -4 \\ 1 \end{pmatrix}$.

Calculate $|4\mathbf{u} - 2\mathbf{v}|$.

2

6. (a) Factorise $p^2 - 4q^2$.

1

(b) Hence simplify $\frac{p^2 - 4q^2}{3p + 6q}$.

2

7.

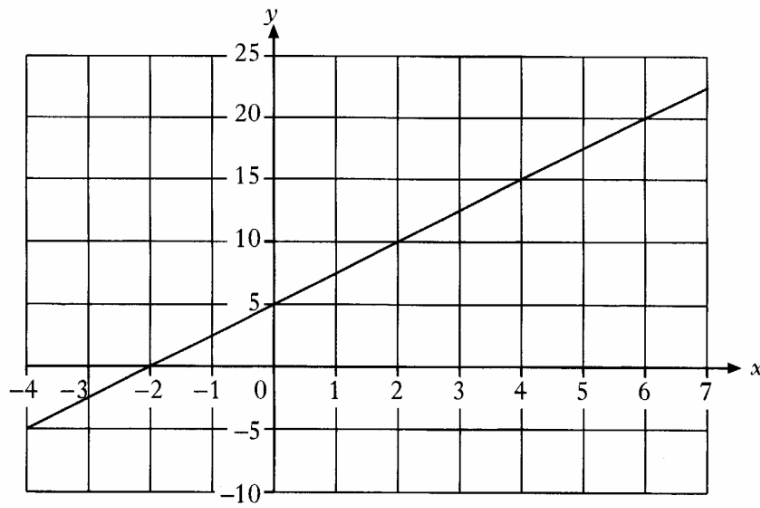

Find the equation of the straight line shown in the diagram.

Give your answer in the form $y = mx + c$.

3

8.

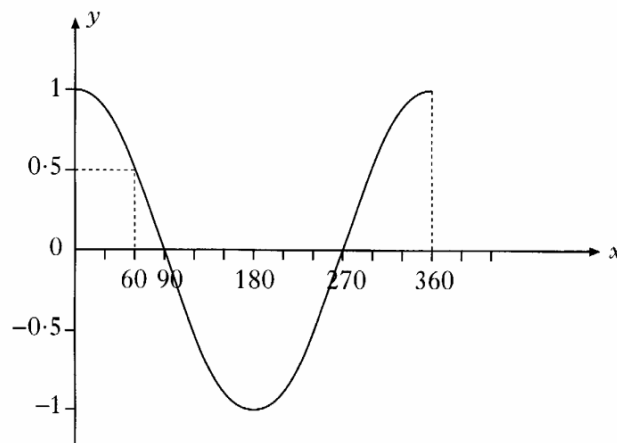

Part of the graph of $y = \cos x^\circ$ is shown above.

If $\cos 60^\circ = 0.5$, state two values for x for which $\cos x^\circ = -0.5$, $0 \leq x \leq 360$.

2

9. Multiply out the brackets and collect like terms.

$$(x - 3)(x^2 + 4x - 1)$$

3

10. A sample of students was asked how many times each had visited the cinema in the last three months.

The results are shown below.

4	5	4	1	4	3	2	2	4	6	2
3	4	4	1	3	1	2	3	1	1	

- (a) From the above data, find the median, the lower quartile and the upper quartile. 3
- (b) Calculate the semi-interquartile range. 1
- (c) The same sample of students was asked how many times each had attended a football match in the same three months.

The data had a median of 5 and a semi-interquartile range of 3.

Make two appropriate comments comparing students visiting the cinema and students attending a football match. 2

11. Two functions are given below.

$$f(x) = x^2 + 2x - 1$$

$$g(x) = 5x + 3$$

Find the values of x for which $f(x) = g(x)$. 3

12. Express in its simplest form

$$y^8 \times (y^3)^{-2} \quad \text{2}$$

13.

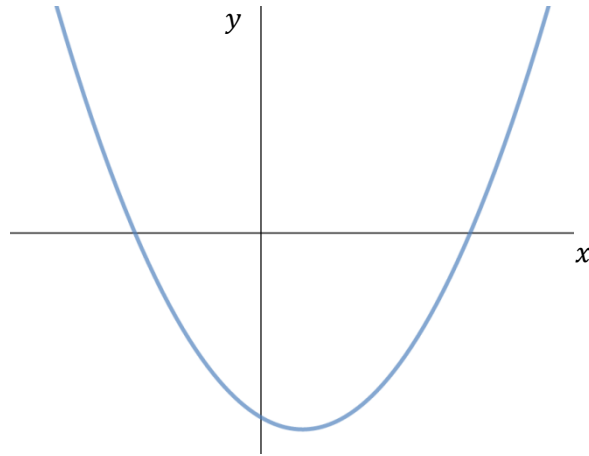

The equation of the parabola in the above diagram is

$$y = (x - 1)^2 - 16.$$

- (a) State the coordinates of the minimum turning point of the parabola. 2
- (b) State the equation of the axis of symmetry of the parabola. 1

14. (a) Express $\sqrt{45} - 2\sqrt{5}$ as a surd in its simplest form. 2
- (b) Express as a fraction in its simplest form

$$\frac{1}{x^2} + \frac{1}{x}, \quad x \neq 0 \quad 2$$

[End of question paper]



Mathematics

National 5 Practice Paper B

Paper 2

Duration - 1 hour and 30 minutes

Total marks - 50

- You may use a calculator
- Attempt all the questions.
- Use **blue** or **black** ink.
- Full credit will only be given to solutions which contain appropriate working.
- State the units for your answer where appropriate.

1. A spider weighs approximately 19.06×10^{-5} kilograms.
A humming bird is 18 times heavier.
Calculate the weight of the humming bird.
Give your answer in scientific notation. 2

2. A microwave oven is sold for £150.
This price includes VAT at 20%.
Calculate the price of the microwave oven without VAT. 3

3. (a) The price, in pence, of a carton of milk in six different supermarkets is shown below.

66 70 89 75 79 59

Use an appropriate formula to calculate the mean and standard deviation of these prices.

Show clearly all your working. 4

- (b) In six local shops, the mean price of a carton of milk is 73 pence with a standard deviation of 17.7 pence.
Compare the supermarket prices with those of the local shops. 2

4. A pendulum travels along an arc of a circle, centre C.

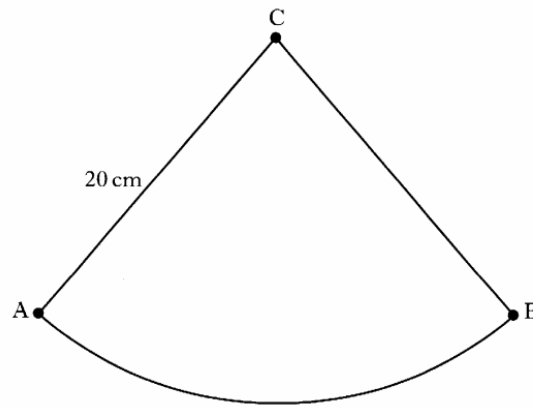

The length of the pendulum is 20 centimetres.

The pendulum swings from A to B.

The length of the arc AB is 28.6 centimetres.

Find the angle through which the pendulum swings from A to B.

4

5. A container to hold chocolates is in the shape of part of a cone with dimensions as shown below.

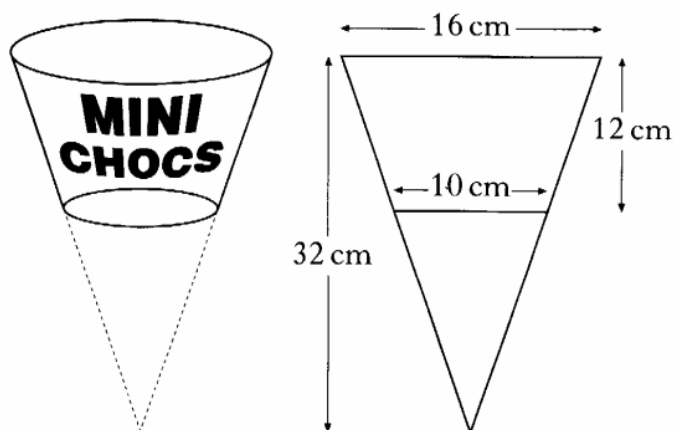

Calculate the volume of the container.

Give your answer correct to one significant figure.

5

6. Solve the equation

$$2x^2 + 3x - 1 = 0.$$

Give your answers correct to one decimal place.

4

7. The diagram below shows a circular cross-section of a cylindrical oil tank.

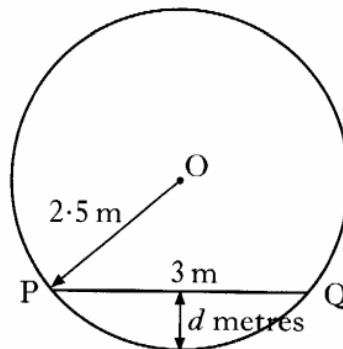

In the figure below,

- O represents the centre of the circle.
- PQ represents the surface of the oil in the tank.
- PQ is 3 metres.
- The radius OP is 2.5 metres.

Find the depth, d metres, of oil in the tank.

4

8. The population of Newtown is 50 000.
The population of Newtown is increasing at a steady rate of 5% per annum.
The population of Auldtown is 108 000.
The population of Auldtown is decreasing at a steady rate of 20% per annum.
- How many years will it take until the population of Newtown is greater than the population of Auldtown?

5

9. A TV signal is sent from a transmitter (T) via a satellite (S) to a village (V), as shown in the diagram. The village is 500 kilometres from the transmitter.

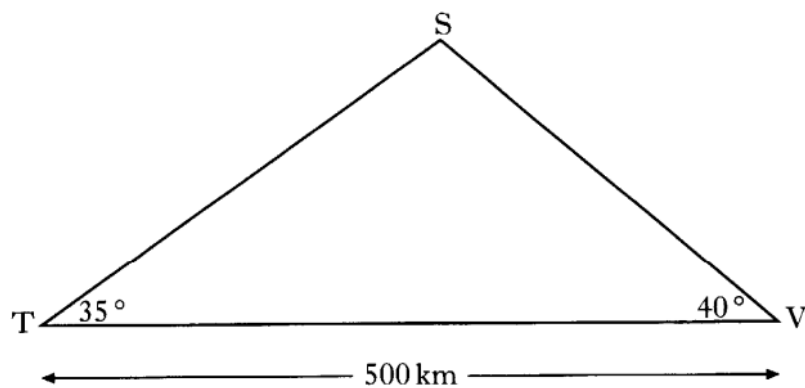

The signal is sent out at an angle of 35° and is received in the village at an angle of 40° .

Calculate the height of the satellite above the ground.

5

10. Change the subject of the formula to p .

$$r = 3p - 2t$$

2

11. Look at the cuboid shown on the coordinate diagram.

The coordinates of point E are $(5,3,1)$

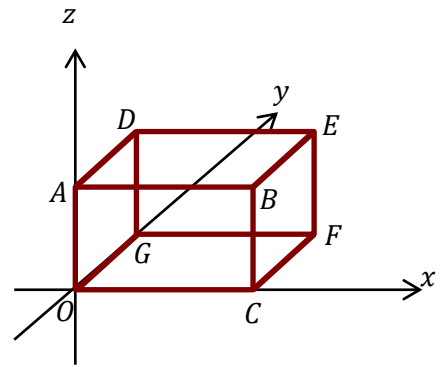

- (a) State the coordinates of F
- (b) State the coordinates of G
- (c) What is the shortest distance between points D and C ?

4

12. At the carnival, the height, H metres, of a carriage on the big wheel above the ground is given by the formula

$$H = 10 + 5 \sin t^\circ,$$

t seconds after starting to turn.

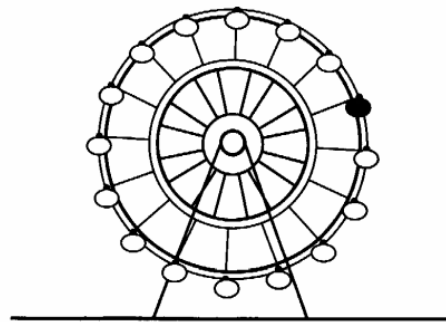

- (a) Find the height of the carriage above the ground after 10 seconds.
- (b) Find the two times during the first turn of the wheel when the carriage is 12.5 metres above the ground.

2

4

[End of question paper]